

Centre Number						Candidate Number				
Surname										
Other Names										
Candidate Signature										

For Examiner's Use	
Examiner's Initials	
Question	Mark
1	
2	
3	
4	
5	
6	
7	
TOTAL	



General Certificate of Secondary Education
Higher Tier
June 2013

Science A

Unit Chemistry C1

CH1HP

H

Chemistry

Unit Chemistry C1

Monday 10 June 2013 1.30 pm to 2.30 pm

For this paper you must have:

- a ruler
 - the Chemistry Data Sheet (enclosed).
- You may use a calculator.

Time allowed

- 1 hour

Instructions

- Use black ink or black ball-point pen.
- Fill in the boxes at the top of this page.
- Answer **all** questions.
- You must answer the questions in the spaces provided. Do not write outside the box around each page or on blank pages.
- Do all rough work in this book. Cross through any work you do not want to be marked.

Information

- The marks for questions are shown in brackets.
- The maximum mark for this paper is 60.
- You are expected to use a calculator where appropriate.
- You are reminded of the need for good English and clear presentation in your answers.
- Question 3(b) should be answered in continuous prose.
In this question you will be marked on your ability to:
 - use good English
 - organise information clearly
 - use specialist vocabulary where appropriate.

Advice

- In all calculations, show clearly how you work out your answer.



J U N 1 3 C H 1 H P 0 1

Answer **all** questions in the spaces provided.

1 Aluminium has many uses.

1 (a) An aluminium atom has 13 electrons.

1 (a) (i) Draw the electronic structure of an aluminium atom.

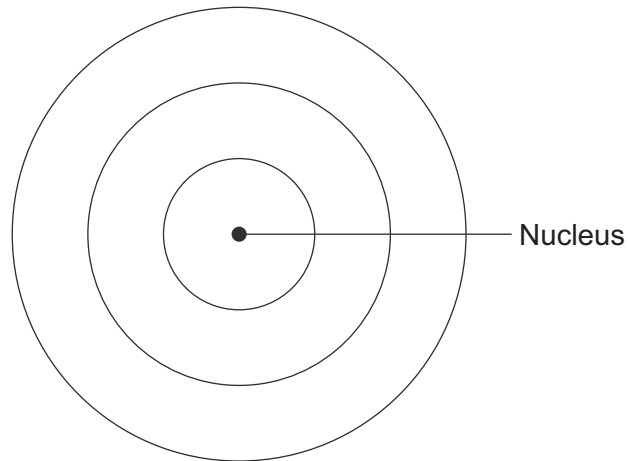

(1 mark)

1 (a) (ii) Name the **two** sub-atomic particles in the nucleus of an aluminium atom.

..... and

(1 mark)

1 (a) (iii) Why is there no overall electrical charge on an aluminium atom?

.....
.....

(1 mark)



1 (b) Rail tracks are made from steel.

Molten iron is used to weld rail tracks.

The reaction of aluminium with iron oxide is used to produce molten iron.

1 (b) (i) Balance the chemical equation for the reaction.

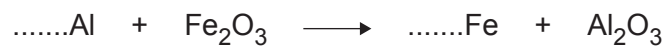

(1 mark)

1 (b) (ii) Why does aluminium react with iron oxide?

.....

.....

(1 mark)

5

Turn over for the next question

Turn over ►



2 Metals are extracted from their ores.

Many copper ores contain only 2% of copper compounds.

2 (a) Copper is now extracted from ores containing a low percentage of copper compounds.

Suggest **two** reasons why.

.....

.....

.....

.....

(2 marks)

2 (b) Chalcocite, an ore of copper, contains copper sulfide.
The flow diagram shows how copper metal is extracted from chalcocite.

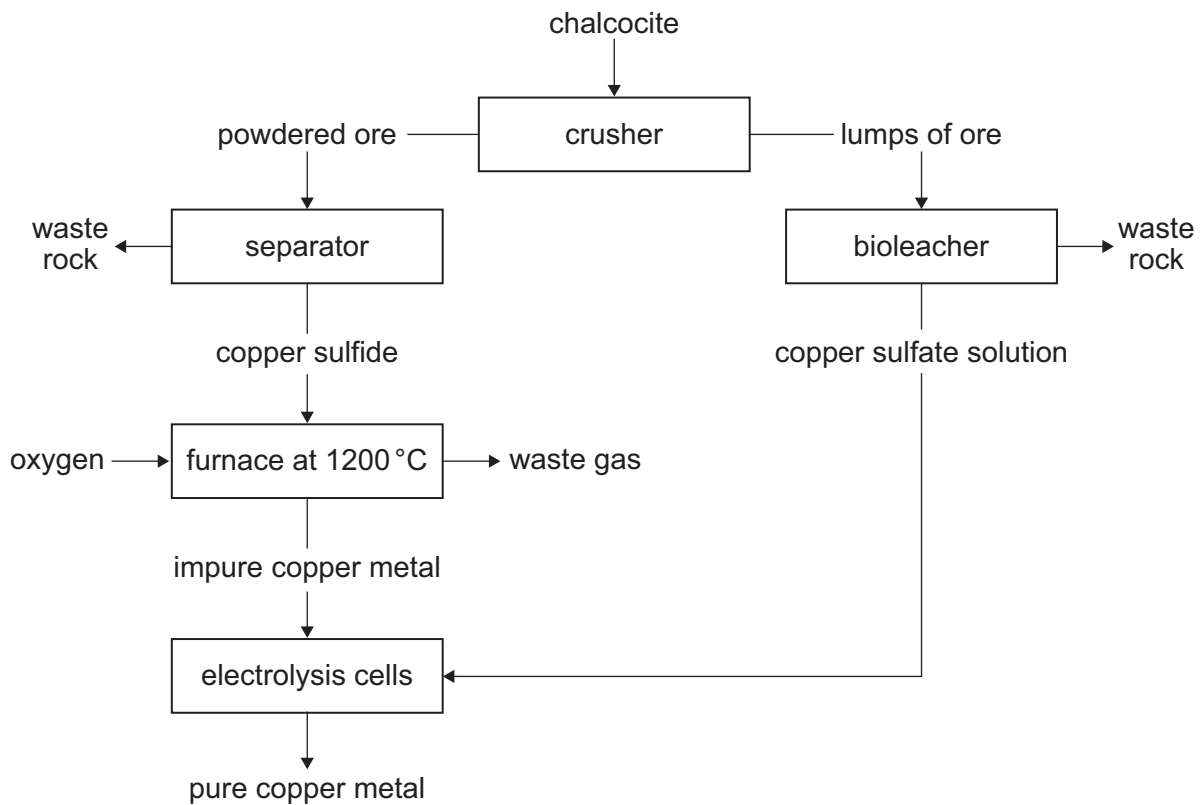

2 (b) (i) Suggest **one** reason why it is difficult to dispose of the waste rock.

.....
.....

(1 mark)

2 (b) (ii) The reaction in the furnace could cause environmental pollution.
Explain how.

.....
.....
.....
.....

(2 marks)

2 (b) (iii) The extraction of pure copper is expensive.
Give **one** reason why.

.....
.....

(1 mark)

2 (b) (iv) Pure copper is produced by electrolysis of copper sulfate solution.

Which electrode do the copper ions move towards?
Give a reason for your answer.

.....
.....
.....
.....

(2 marks)

2 (b) (v) Large areas of land are contaminated with copper compounds.
Phytomining can be used to remove these copper compounds from the land.

What is used in phytomining to remove copper compounds from the land?

.....
.....

(1 mark)

9

Turn over ►



3 Crude oil is a mixture of many different chemical compounds.

3 (a) Fuels, such as petrol (gasoline), can be produced from crude oil.

3 (a) (i) Fuels react with oxygen to release energy.

Name the type of reaction that releases energy from a fuel.

.....
(1 mark)

3 (a) (ii) Fuels react with oxygen to produce carbon dioxide.
The reaction of a fuel with oxygen can produce a different oxide of carbon.

Name this different oxide of carbon and explain why it is produced.

.....
.....
.....
.....
(2 marks)

3 (b) Most of the compounds in crude oil are hydrocarbons.
Hydrocarbons with the smallest molecules are very volatile.

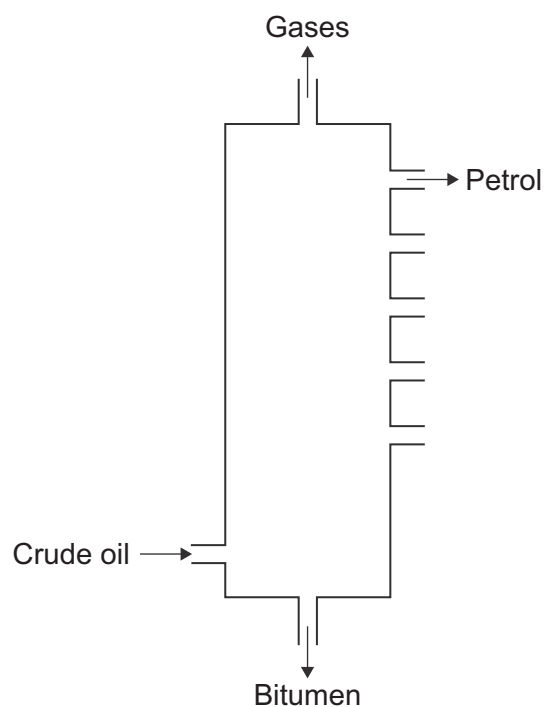

4 The diagram shows a ballpoint pen.

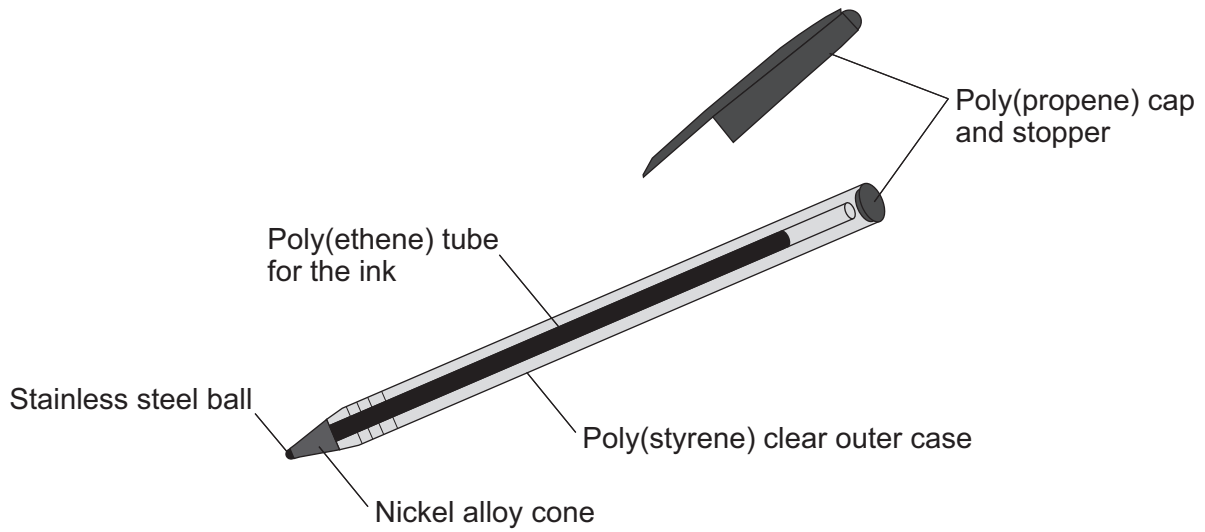

4 (a) Give **one** advantage and **one** disadvantage of recycling the materials from this type of ballpoint pen.

.....
.....
.....
.....

(2 marks)

4 (b) Alloys are used to make the ballpoint pen.

Give **two** reasons why alloys are used in the ballpoint pen.

.....
.....
.....
.....

(2 marks)



4 (c) Decane ($C_{10}H_{22}$) can be used to produce poly(ethene).

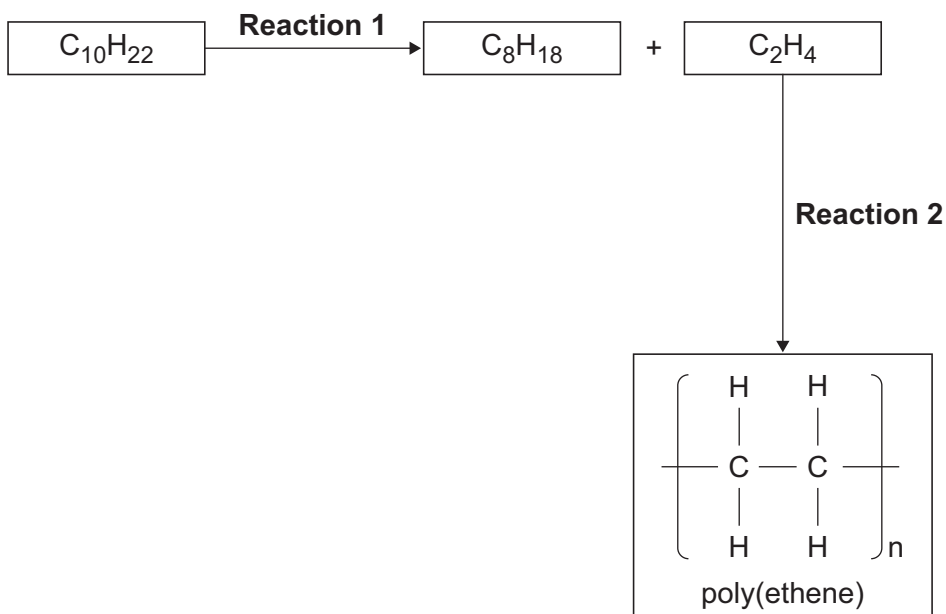

4 (c) (i) Describe the conditions needed for **Reaction 1**.

.....

.....

.....

.....

(2 marks)

4 (c) (ii) Describe, in terms of molecules, how poly(ethene) is produced in **Reaction 2**.

.....

.....

.....

.....

.....

(2 marks)

Question 4 continues on the next page

Turn over ►



- 4 (d) Complete the displayed structure of the product in the equation.

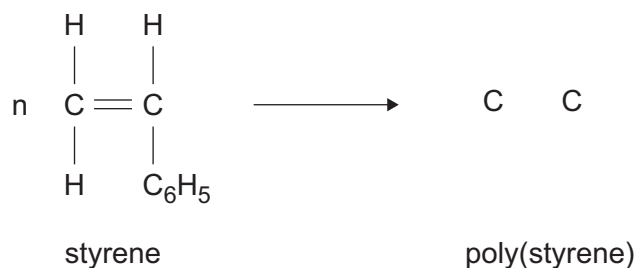

(2 marks)

10

- 5 The amount of carbon dioxide in the Earth's atmosphere has changed since the Earth was formed.
The amount of carbon dioxide continues to change because of human activities.
- 5 (a) Cement is produced when a mixture of calcium carbonate and clay is heated in a rotary kiln. The fuel mixture is a hydrocarbon and air.

Hydrocarbons react with oxygen to produce carbon dioxide.
Calcium carbonate decomposes to produce carbon dioxide.

- 5 (a) (i) Complete each chemical equation by writing the formula of the other product.

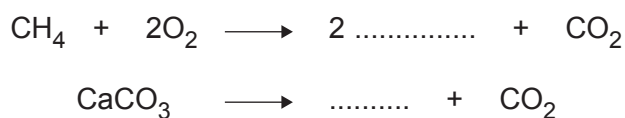

(2 marks)

- 5 (a) (ii) Hydrocarbons and calcium carbonate contain *locked up* carbon dioxide.

What is *locked up* carbon dioxide?

.....

.....

.....

.....

(2 marks)



5 (b) **Graph 1** shows how the percentage of carbon dioxide in the atmosphere changed in the last 4500 million years.

Graph 1

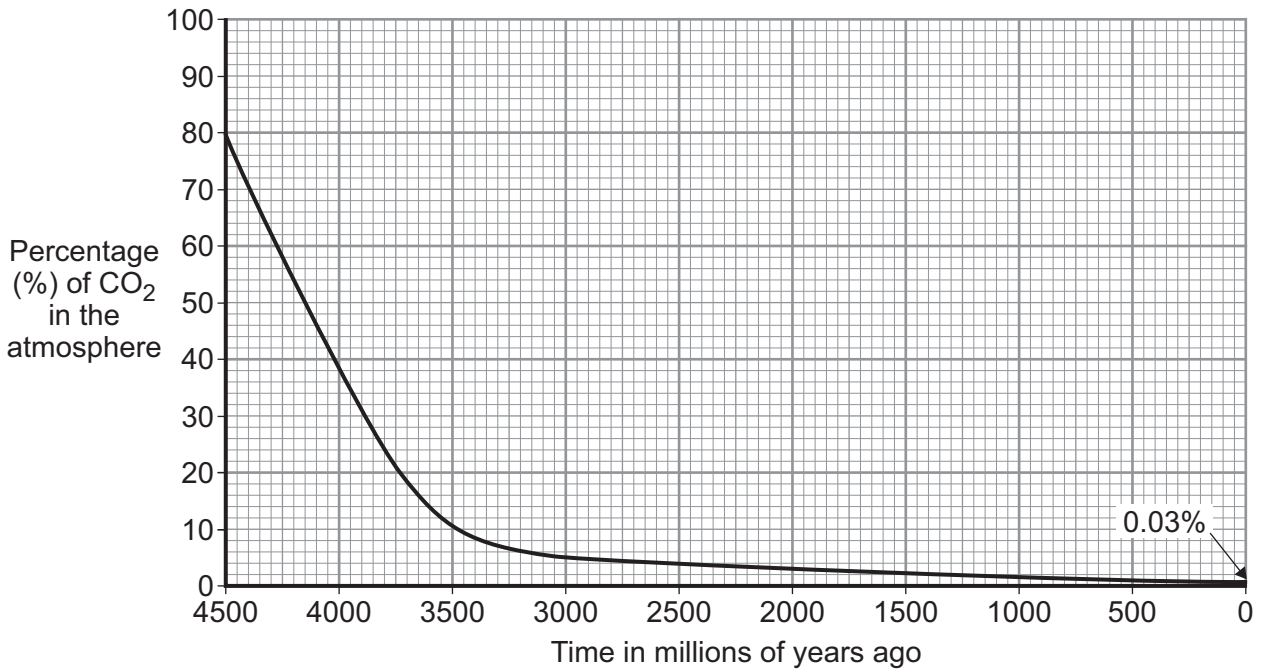

Use information from **Graph 1** to answer these questions.

5 (b) (i) Describe how the percentage of carbon dioxide has changed in the last 4500 million years.

.....

.....

.....

.....

(2 marks)

5 (b) (ii) Give **two** reasons why the percentage of carbon dioxide has changed.

.....

.....

.....

.....

(2 marks)

Question 5 continues on the next page

Turn over ►



5 (c) **Graph 2** shows how the percentage of carbon dioxide in the atmosphere changed in the last 250 years.

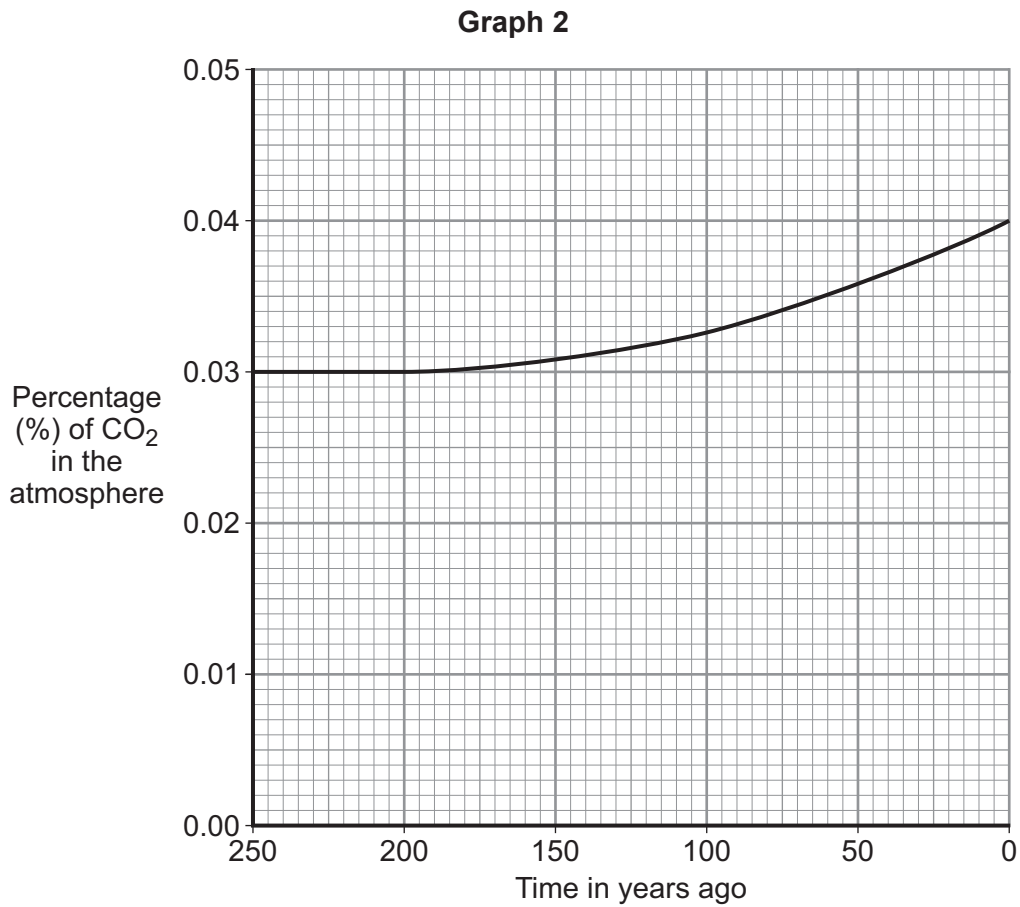

Should we be concerned about this change in the percentage of carbon dioxide?

Explain your answer.

.....

.....

.....

.....

(2 marks)

10



6 There were many ideas about how the Earth was formed from a molten ball of rock and minerals.

At one time scientists thought the features of the Earth were caused when the molten ball of rock and minerals cooled and wrinkled.

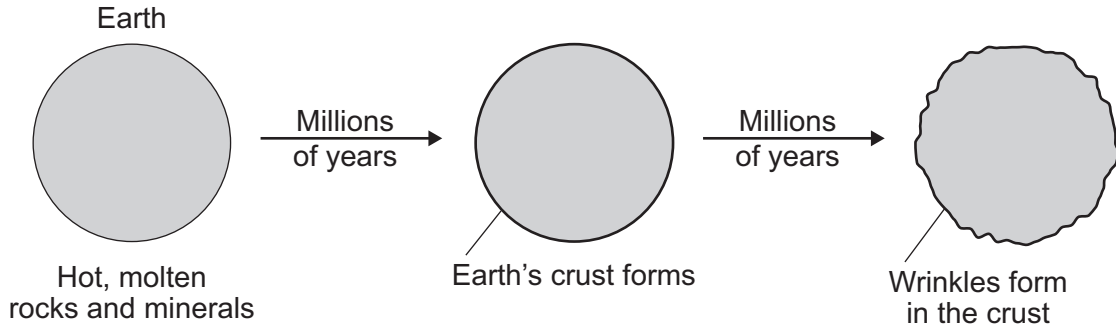

6 (a) Scientists now have evidence that the Earth has a layered structure.

Describe the layered structure of the Earth. You should indicate the relative sizes of the layers.

.....

.....

.....

.....

.....

.....

(3 marks)

6 (b) At one time scientists thought the Earth's continents were formed in fixed positions when the molten ball of rock and minerals cooled and wrinkled.

In 1912, the scientist Alfred Wegener suggested his idea about how Earth's continents formed.

Describe Wegener's idea of how Earth's continents formed.

.....

.....

.....

.....

(2 marks)

5

Turn over ►



7 There has been research into fuels for car engines.

Fuel	Content	Melting point in °C	Flashpoint in °C	Energy released in MJ per litre
Ethanol	C ₂ H ₅ OH	-114	+14	21.2
Diesel	hydrocarbons	About -24	+64	38.6
Petrol	hydrocarbons	About -57	-45	34.8
Rapeseed oil	fats	About +5	+130	32.8

The flashpoint is the lowest temperature a fuel vapour ignites in air.

7 (a) The melting point of ethanol is precise but the other melting points are approximate. Suggest why.

.....

.....

.....

(2 marks)

7 (b) Ethanol is produced by fermentation of sugar cane. Rapeseed oil is produced by pressing rapeseeds. Waste plant material from both processes is used to feed animals.

7 (b) (i) Describe how the process of fermentation is done.

.....

.....

.....

.....

(2 marks)

7 (b) (ii) Carbon neutral fuels do **not** increase the amount of carbon dioxide in the atmosphere.

Suggest why using a biofuel, such as ethanol or rapeseed oil, is thought to be carbon neutral.

.....

.....

.....

.....

(2 marks)



7 (c) When any fuel from the table is used in a car engine, the exhaust gases contain nitrogen oxides.

Explain why.

.....

.....

.....

.....

(2 marks)

7 (d) Evaluate replacing petrol with ethanol as a fuel for cars.

To gain full marks you should give a justified conclusion.

Use the information from the table and your knowledge to answer this question.

.....

.....

.....

.....

.....

.....

.....

.....

.....

.....

.....

.....

.....

.....

.....

.....

.....

.....

.....

(4 marks)

12

END OF QUESTIONS



There are no questions printed on this page

**DO NOT WRITE ON THIS PAGE
ANSWER IN THE SPACES PROVIDED**

